

## BIONIQ SQUARE ADJUSTABLE COMFORT TRIMLESS

**A35212-** \_\_\_\_\_  
 base number    Color \_\_\_\_\_    Finishes \_\_\_\_\_    Finishes \_\_\_\_\_    Finishes \_\_\_\_\_    Ceiling \_\_\_\_\_    Reflector \_\_\_\_\_  
 Temperature    (Diamond)    (Triangle)    (Circle)    Thickness    Options

- To build a product code in our configurator select the specify button on the base model # product page
- To build a manual product code on this datasheet choose from the options listed below in blue font and add the suffix to the base model #

**GENERAL**  
 Series: Bioniq  
 Subseries: Bioniq Square Adjustable Comfort  
 Brand: Prolicht  
 Division: Architectural  
 Mounting Type: Trimless  
 Mounting Location: Ceiling  
 Subcategory: Downlight

**PHYSICAL**  
 Shape: Square  
 Length (mm): 106  
 Length (in): 4 3/16  
 Width (mm): 106  
 Width (in): 4 3/16  
 Height (mm): 134  
 Height (in): 5 1/4  
 Ceiling Thickness (mm): 10 / 12.5 / 15 / 25  
 Ceiling Thickness (in): 3/8 or 1/2 or 9/16 or 1  
 Min. Recessing Depth (mm): 150  
 Min. Recessing Depth (in): 5 7/8  
 Light Distribution: Adjustable / Downlight  
 Weight (kg): 0.655  
 Weight (lbs): 1.44  
 Fixture Finish: SSR / BKV / CWI / CRY / HAB / UFT / ITA / RUA / FTG / MYG / LOD / PUS / FRO / FUP / KIA / POP / BLS / SPG / MEY / GOH / GUM / CHC / COM / ABZ / JAG / OBR / MOS / ROR  
 Fixture Material: Aluminum Die Cast  
 Cut-out Measurements: 120mm / 4 3/4" x 120mm / 4 3/4"  
 Upon Request: Unique Ceiling Thickness

**ELECTRICAL**  
 Lamp Type: LED (Zhaga Standard)  
 Input Wattage (W): 15.5  
 Total Output Wattage (W): 14.5  
 Dimming: Tri-Mode (Non-Dimming and Phase Dimming (120Vac only) and 0-10V Dimming)  
 Driver Included: No  
 Driver Location: Recessed Housing  
 Driver Type: Constant Current - Universal  
 Driver Class: Class 2  
 Housing: See components  
 Input Voltage (V): 120 - 277  
 Constant Current (MA): 500

**LED**  
 Number of LEDs: 1  
 Color Temperature (°K): 2700 / 3000 / 3500 / 4000  
 Max. Delivered Lumen (lm): 940 / 980 / 1029 / 1050  
 Nominal Lumen (lm): 1386 / 1438 / 1511 / 1542  
 CRI: >90 CRI  
 Efficiency (%): 87.9 / 88.4 / 87.9  
 Lamp Life (hrs): 50000  
 Upon Request: RGB-W Tunable White Special Color Temperature Special LED

**OPTICAL**  
 Reflector: 20 / 40 / 60  
 Adjustability: Rotational 355°; Tilt 30°  
 Upon Request: Special Beam Angles

**RATINGS AND CERTIFICATIONS**  
 Zaneen Inc. © 2022, T 909-880-3382, F 416-247-9319, www.zaneen.com

Available for international specifications by adding "INT" at the end of the existing Model #. For assistance on 'custom' specifications, contact zteam@zaneen.com.  
 In a constant effort to supply the best product, we reserve the right to change specifications or materials without notice. The most recent specification sheets are found at zaneen.com  
 IP rating: IP20



## BIONIQ SQUARE ADJUSTABLE COMFORT TRIMLESS

A35212-

PROJECT

TYPE

SPECIFIER

QUANTITY

DATE

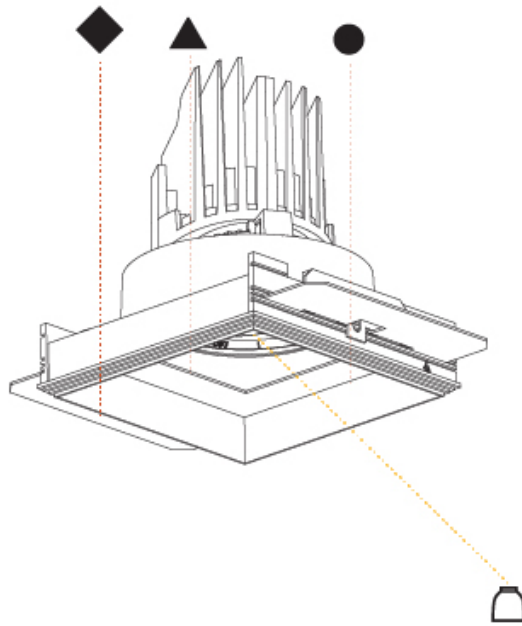

## BIONIQ SQUARE ADJUSTABLE COMFORT TRIMLESS

**A35215-** \_\_\_\_\_  
 base number LED Dimming Color Temperature Finishes (Diamond) Finishes (Triangle) Finishes (Circle) Ceiling Thickness

- To build a product code in our configurator select the specify button on the base model # product page
- To build a manual product code on this datasheet choose from the options listed below in blue font and add the suffix to the base model #

### GENERAL

Series: Bioniq  
 Subseries: Bioniq Square Adjustable Comfort  
 Brand: Prolicht  
 Division: Architectural  
 Mounting Type: Trimless  
 Mounting Location: Ceiling  
 Subcategory: Downlight

### PHYSICAL

Shape: Square  
 Length (mm): 106  
 Length (in): 4 <sup>3</sup>/<sub>16</sub>  
 Width (mm): 106  
 Width (in): 4 <sup>3</sup>/<sub>16</sub>  
 Height (mm): 134  
 Height (in): 5 <sup>1</sup>/<sub>4</sub>  
[Ceiling Thickness \(mm\): 10 / 12.5 / 15 / 25](#)  
 Ceiling Thickness (in): 3/8 or 1/2 or 9/16 or 1  
 Min. Recessing Depth (mm): 150  
 Min. Recessing Depth (in): 5 <sup>7</sup>/<sub>8</sub>  
 Light Distribution: Adjustable / Downlight  
 Weight (kg): 0.655  
 Weight (lbs): 1.44  
[Fixture Finish: SSR / BKV / CWI / CRY / HAB / UFT / ITA / RUA / FTG / MYG / LOD / PUS / FRO / FUP / KIA / POP / BLS / SPG / MEY / GOH / GUM / CHC / COM / ABZ / JAG / OBR / MOS / ROR](#)  
 Fixture Material: Aluminum Die Cast  
 Cut-out Measurements: 120mm / 4 3/4" x 120mm / 4 3/4"  
 Upon Request: Unique Ceiling Thickness

### ELECTRICAL

Lamp Type: LED (Zhaga Standard)  
 Input Wattage (W): 13.2 / 16.5  
 Total Output Wattage (W): 12.1 / 14.7  
[Dimming: Tri-Mode \(Non-Dimming and Phase Dimming \(120Vac only\) and 0-10V Dimming\)](#)  
 Driver Included: No  
 Driver Location: Recessed Housing  
 Driver Type: Constant Current - Universal  
 Driver Class: Class 2  
 Housing: See components  
 Input Voltage (V): 120 - 277  
 Constant Current (MA): 350

### LED

Number of LEDs: 1  
[Color Temperature \(°K\): 2700 / 3000 / 3500 / 4000](#)  
 Max. Delivered Lumen (lm): 850 / 950 / 1019 / 1040  
 Nominal Lumen (lm): 960 / 1070 / 1156 / 1180  
 CRI: >90 CRI  
 Efficiency (%): 88.5  
 Lamp Life (hrs): 50000  
 Upon Request: RGB-W Tunable White Special Color Temperature  
 Special LED

### OPTICAL

Reflector°: 10  
 Adjustability: Rotational 355°; Tilt 30°  
 Upon Request: Special Beam Angles

**RATINGS AND CERTIFICATIONS**  
 © 2024 Zaneen LLC, 10000 180-3382, F 416-247-9319, www.zaneen.com

Available for international specifications by adding "INT" at the end of the existing Model #. For assistance on 'custom' specifications, contact zteam@zaneen.com.  
 Certified By: Certified for North American Standards  
 In a constant effort to supply the best product, we reserve the right to change specifications or materials without notice. The most recent specification sheets are found at zaneen.com  
 IP rating: IP20

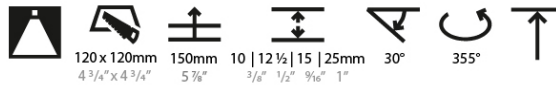
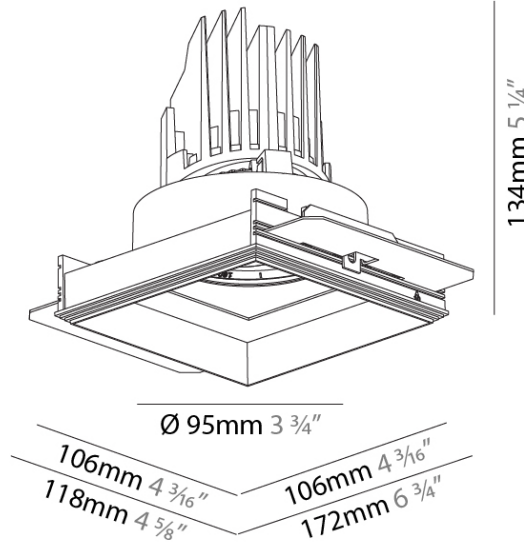

## BIONIQ SQUARE ADJUSTABLE COMFORT TRIMLESS

A35215-

PROJECT \_\_\_\_\_

TYPE \_\_\_\_\_

SPECIFIER \_\_\_\_\_

QUANTITY \_\_\_\_\_

DATE \_\_\_\_\_



A

## BIONIQ SQUARE ADJUSTABLE COMFORT TRIMLESS

**A35531-** \_\_\_\_\_  
 base number Finishes (Diamond) Finishes (Triangle) Finishes (Circle) Ceiling Thickness Reflector Options

- To build a product code in our configurator select the specify button on the base model # product page
- To build a manual product code on this datasheet choose from the options listed below in blue font and add the suffix to the base model #

### GENERAL

Series: Bioniq  
 Subseries: Bioniq Square Adjustable Comfort  
 Brand: Prolicht  
 Division: Architectural  
 Mounting Type: Trimless  
 Mounting Location: Ceiling  
 Subcategory: Downlight

### PHYSICAL

Shape: Square  
 Length (mm): 106  
 Length (in): 4 3/16  
 Width (mm): 106  
 Width (in): 4 3/16  
 Height (mm): 134  
 Height (in): 5 1/4  
 Ceiling Thickness (mm): 10 / 12.5 / 15 / 25  
 Ceiling Thickness (in): 3/8 or 1/2 or 9/16 or 1  
 Min. Recessing Depth (mm): 150  
 Min. Recessing Depth (in): 5 7/8  
 Light Distribution: Adjustable / Downlight  
 Weight (kg): 0.704  
 Weight (lbs): 1.55  
 Fixture Finish: SSR / BKV / CWI / CRY / HAB / UFT / ITA / RUA / FTG / MYG / LOD / PUS / FRO / FUP / KIA / POP / BLS / SPG / MEY / GOH / GUM / CHC / COM / ABZ / JAG / OBR / MOS / ROR  
 Fixture Material: Aluminum Die Cast

Cut-out Measurements: 120mm / 4 3/4" x 120mm / 4 3/4"  
 Upon Request: Unique Ceiling Thickness

### ELECTRICAL

Lamp Type: LED (Zhaga Standard)  
 Input Wattage (W): 16.5  
 Total Output Wattage (W): 14.7  
 Dimming: Dali Dimming  
 Driver Included: No  
 Driver Location: Recessed Housing  
 Driver Type: Constant Current - 120Vac  
 Driver Class: Class 2  
 Housing: See Components  
 Input Voltage (V): 120  
 Constant Current (MA): 350

### LED

Number of LEDs: 1  
 Max. Delivered Lumen (lm): 770  
 Nominal Lumen (lm): 1140  
 CRI: >90 CRI  
 Lamp Life (hrs): 50000  
 Upon Request: RGB-W Tunable White Special Color Temperature Special LED

### OPTICAL

Reflector: 20 / 40 / 60  
 Adjustability: Rotational 355°; Tilt 30°  
 Upon Request: Special Beam Angles

### RATINGS AND CERTIFICATIONS

382, F 416-247-9319, www.zaneen.com  
 Certified and created for North American standards at the end of the existing Model #. For assistance on 'custom' specifications, contact zteam@zaneen.com.  
 In a constant effort to supply the best product, we reserve the right to change specifications or materials without notice. The most recent specification sheets are found at zaneen.com  
 IP rating: IP20

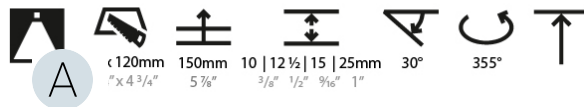
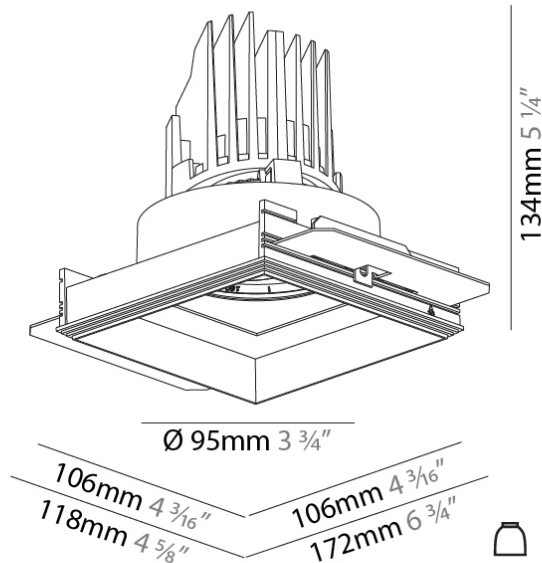

## BIONIQ SQUARE ADJUSTABLE COMFORT TRIMLESS

A35531-

PROJECT

TYPE

SPECIFIER

QUANTITY

DATE



A

PROJECT
TYPE
SPECIFIER
QUANTITY
DATE

### Fixture Finish



**Digital:** Not all screens are calibrated the same, and therefore, colors will appear differently between screens.





































































**Physical:** When texture is involved, there will be variations in color, character and tone within a product series and between product families.

**Gun Metal:** No Gun Metal finish is alike. It combines a mixture of transparent and black color particles which ensures a highly individual effect and no luminaire being identical.











**Champagne Cream, Copper Mine, Ancient Bronze + Jazz Gold:** These finishes have slight fading from specific powder coating production. Each luminaire will slightly vary.













### LEGEND

 floor-mounted	 pivotable	 special LED (upon request) RGB, RGBW, tunable, gold+, meat+, art+, fashion+
 wall and ceiling: recessed and surface mounted	 rotating	 warm dim / natural dimming LED
 ceiling-mounted and wall-mounted	 illuminate tilted	 rechargeable battery powered
 wall-mounted	 color of suspension cable	 fixture with natural vivid LED (upon request)
 omni-directional light distribution	 length of suspension cable	 color rendering index
 direct light distribution	 reflector degree selection	 color temperature
 direct/indirect light distribution	 super spot	 lumen (luminous flux)
 indirect light distribution	 lens	 efficacy (lumens per watt)
 asymmetric light distribution	 lens pack	 Unified Glare Rating (UGR) range from 5-40
 aura light distribution	 shine ring	 marine grade (AISI 316 stainless steel)
 round wall or ceiling cut-out	 integrated shine ring with diffuser	 walk on
 square wall or ceiling cut-out	 free individual colors 01-29	 drive on
 the supplied jig specifies the cutout dimensions	 individual colors: 00 (free of charge), 01-25 (extra charge)	 Dark Sky Compliance
 minimum distance (meters) lamp - object	 luminaire part to be colored (F1)	 Americans with Disabilities Act (less than 4" off the wall located between 27"-84" from floor)
 recessed depth	 luminaire part to be colored (F2)	 lamp protected against explosion
 ceiling thickness in mm	 luminaire part to be colored (F3)	 blown glass using traditional methods by master glass blower
 ceiling thickness selection	 luminaire part to be colored (F4)	 acoustic material
 dimmable DP (phase), DV (0-10V), DD (dali), DS (step-dim)	 luminaire part to be colored (F5)	 protection class I, protection insulation
 included or excluded LED driver/transformer/control gear	 color of 3-circuit adaptor	 protection class II, protection insulation
 separately switchable	 indirect diffuser	 ETL Certified to UL and CSA Standards
 sensor	 direct diffuser	 UL Certified to UL and CSA Standards
 remote control	 ball-proof (upon request)	 CSA Certified to UL and CSA Standards
 available upon request	 accessory	 Certified for North American Standards

### IP RATING

 IP20	protected against ingress of solid bodies greater than 12.5mm (finger)
 IP33	protected against ingress of solid bodies greater than 2.5mm protected against sprays of water up to 60 degrees from the vertical (rain)
 IP40	protected against ingress of solid bodies greater than 1mm (wire) no protection against the ingress of moisture
 IP43	protected against ingress of solid bodies greater than 1mm (wire) protected against sprays of water up to 60 degrees from the vertical (rain)
 IP44	protected against ingress of solid bodies greater than 1mm (wire) protected against water splashed from all directions
 IP54	protected against limited ingress of dust (wet rooms/covered outdoor areas) protected against water splashed from all directions
 IP65	protected against ingress of dust protected against jets of water
 IP66	protected against ingress of dust protected against powerful jets of water or heavy seas
 IP67	protected against ingress of dust protected against immersion of water between 15cm - 1m for 30 minutes
 IP68	protected against ingress of dust protected against immersion of water under pressure for long periods

### IK RATING

 IK01	protected against 0.14 joules impact (equivalent to 0.25kg mass dropped from 56mm above the surface)
 IK02	protected against 0.2 joules impact (equivalent to 0.25kg mass dropped from 80mm above the surface)
 IK03	protected against 0.35 joules impact (equivalent to 0.25kg mass dropped from 140mm above the surface)
 IK04	protected against 0.5 joules impact (equivalent to 0.25kg mass dropped from 200mm above the surface)
 IK05	protected against 0.7 joules impact (equivalent to 0.25kg mass dropped from 280mm above the surface)
 IK06	protected against 1 joules impact (equivalent to 0.25kg mass dropped from 400mm above the surface)
 IK07	protected against 2 joules impact (equivalent to 0.5kg mass dropped from 400mm above the surface)
 IK08	protected against 5 joules impact (equivalent to 1.7kg mass dropped from 300mm above the surface)
 IK09	protected against 10 joules impact (equivalent to 5.0kg mass dropped from 200mm above the surface)
 IK10	protected against 20 joules impact (equivalent to 5.0kg mass dropped from 400mm above the surface)